



*Please read and keep  
the instruction*



*in door use only.*



*Don't discard*

# *Commercial Coffee Brewer*

## *Operating Instructions*

*R Series*



**CE**



***Read the instructions before using the appliance.***



***Caution! Hot Surface!***

## **INTRODUCTION:**

We are really pleased that you have chosen our high quality product of Automatic Coffee Machine, and we are very sure that you have made a correct decision. Before your use it, please read the following instructions carefully.

## **WARNING:**

The following warnings and precautions must be observed.

- ☆ Never immerse the machine in the water. If the machine has been soaked, it must be dried and checked by specialist before using it again.
- ☆ Never pour hot water into the Water Reservoir.
- ☆ Never pour more than 2.2 liter of water into the Water Reservoir
- ☆ When working, the unit has to be placed in a horizontal position.
- ☆ Unit only suitable for indoor and countertop to use.
- ☆ Before installation, you should confirm the rating plate on the machine is suitable for your electric outlet.
- ☆ When the machine is in use, some parts of the machine are very hot. Ensure the power cord does not touch the hot parts. The use should also be careful not to touch the hot parts.
- ☆ Remain in the vicinity of the machine while machine is in operation.
- ☆ Don't disconnect appliance with wet hands and Don't pull the supply cord.
- ☆ If the supply cord is damaged, it must be replaced by the manufacturer, its service agent or similarly qualified persons in order to avoid a hazard.
- ☆ Please stop to use unit when power cord damaged, the power cord should be replaced by qualified person with specified type, please contact with the service agent or the Sales Rep. of distributor.
- ☆ In the following pages, all the important items are marked by  to attract your attention.



*Disclaimer: The Manufacturer will accept no liability for any injury or damage caused by incorrect usage of the machine or by improper operation contrary to information given in this Instruction Manual.*

## MODEL DESIGNATION:

**R X G 2 0 0 0**

R series brewer

Inlay of panel facing

(X, H, L or U)

Accessories of purposed

(G, T, A, or S)

Mfr. refer code

(Blank, A-Z, or No.)

Amount of warming plate

(0, 1, or 2)



R\*G2001



R\*T0001



R\*A0001



R\*G1001



R\*T1001



R\*S0001

Notice: The \* in the model number is different nameplate designs. The three digits suffix is the refer code; both of them are not impact to any specifications, function or usage of the machine.

## SPECIFICATION:





Model	R**2***	R**1***	R**0***
Rating / 220-240Vac	1885-2243W	1812 – 2156W	1739 – 2069W
Frequency	50~60Hz		
Capacity	Up to 100 cups/Hr		
Brewing Time	1.8 Liter/ 5 Minis		
Brewing Temp.	93~96 °C		

## DIMESION:

Model	**G**	**T**	**A**	**S**
L (mm)	365	365	365	360
W (mm)	195	195	195	260
H (mm)	445	470	555	630

## ACCESSORIES:

The following accessories may purchase separately for different models:

Items	**G**	**T**	**A**	**S**
Filter Paper	✓	✓	✓	✓
Filter Paper(250mm)	Decanter	Vacuum Pot	Airpot	Server
				

## RECOGNIZE:

1. Switch of the Extra Warmer on top.
2. On/off Switch with Indicator
3. Water tank inlet.
4. Extra Warming Plate
5. Filter Pan with Ring Spring
6. Machine Body. (Earthing terminal)
7. Power cable with plug
8. Warming Plate on base.
9. Decanter (or Thermos)
10. "Brewing" Indicator (Green.)
11. "Warning" indicator (Red)

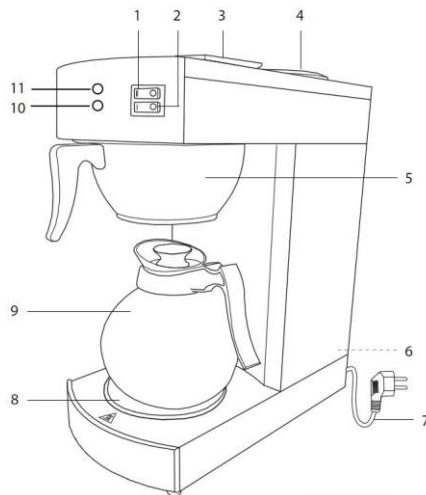

*The Ring Spring must always wedge well on the bottom of Filter Pan. Otherwise coffee will overflow from the Filter Pan.*



*The spring may lose its elastic after used for awhile. To expand it little bit, than it can be resume again.*

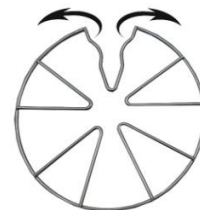

## INSTALLATION:

1. Place the Machine on a firm and horizontal table.
2. *Wedge the Spring well and Slide the Filter Pan into position of machine.*
3. Pour of cold water (no more then 2.2 liter) into the Water Reservoir, wait for 1 minute for water to force the air out of the Machine.
4. Place an empty Glass Decanter, Vacuum Pot or Thermos at correct position under the Filter Pan.
5. Turn the Switch ON and the "Brewing" Indicator lights up.
6. **HOT WATER** starts to flow into Glass Decanter, Vacuum Pot or Thermos.
7. 4~5 minutes later, the "Brewing" Indicator will turn off; the brewing process has ended.
8. You should repeat the above process 2 to 3 times to clean the internal parts of The Machine before brewing coffee for first time.
9. During above operation, it is normal to hear some hissing and billizy sound of water and to see some water vapor coming out.



***DO NOT pour hot water into the Reservoir.***

## OPERATION:

1. Assembly the Filter Pan and put appropriate amount of coffee on a Filter Paper.
2. Slide the Filter Pan into position.
3. Pour a pot of cool water into the water tank.
4. Place an empty Decanter or Pots at the correct position under Filter Pan.
5. Switch the power ON, the “Brewing” Indicator lights up; a process of brewing has begun.
6. Coffee start flows into the Decanter or Pots.
7. When “Brewing” Indicator lights turn off, there is no more coffee flows out from the unit; a brewing cycle has completed.
8. The warmer on the base will continue to heat up, until the user turn the switch off.
9. For the unit without warmers, please turn power OFF, and lock the cap of Pot or Thermos. A pot of coffee can now be served.
10. Although the machine has an overflow pipe in the Reservoir, just in case the amount of water in Reservoir exceeds; the user still should be careful not let the water exceeds 2.2 liter in order to avoid over flow.
11. Since there is always some remaining water in the hoses or boiler of the Machine; if the Machine will not be used for some time, or if the Machine needs to be removed, please pour out the remaining water and clean it before storage.
12. When the Machine is to be used again after a long period, please repeat steps of **Installation**.
13. If the Machine is not to be used for a short time, please clean the Machine with fresh water before using again.
14. When the Warning indicator lights up, it reminds the user to de-scale in time.

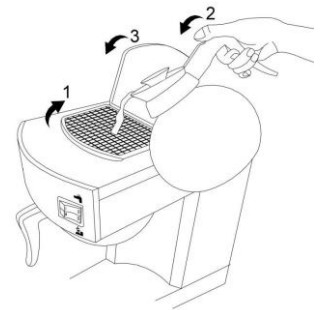

**Caution! Remove the Brew Chamber carefully and slowly when it hot!**



**Caution! Hot Surface!**



**DO NOT keep EMPTY decanter on Warming Plate.**



## **MAINTENANCE:**

### **■ Cleaning**

It is important for the Machine and its accessories be kept clean after using.

- Unplug the coffee maker and allow to cool,
- Wipe all external surfaces including the hotplate with a damp cloth and dry thoroughly.
- The glass jug, pots and filter basket should be washed in warm soapy water than rinse and dry all parts thoroughly.



No parts are suitable for cleaning in a dishwasher.  
Never use harsh or abrasive cleaners.

### **■ De-sediments**

If you operate in a hard water area, we recommend to de-scaling at regular intervals, e.g. every 2-3 months or as required.

If the brewing cycle takes time longer than usual, or the steam condition is bigger than normally, it is a signal that de-scale is necessary.

- Add 300 ml fresh lemon juice or condensed lemon juice to 1 liter of warm water (below 50°C).
- Slide Filter Pan and Place an empty decanter or receptacles at the correct position under the Filter Pan.
- Pour solution of lemon juice into Water Reservoir and Turn the switch ON.
- Some of hot water will drop into the decanter or receptacles until the solution of lemon juice push out the waters remained in the Machine. When there are some solutions of lemon juice drop into the decanter or receptacles, then turn the switch OFF.
- Wait for 5~6 minutes to enable the rest of solution to run through with sediments, then turn the switch ON again.
- When the indicator lights off, set switch OFF and flush the solution away.
- Since some solution will still remain in the Machine, we must run brewing process several times, until there is no more smell of lemon juice in the hot water which flow out from the Machine.
- The machine is ready for server again.



Failure to de-scale will invalidate your guarantee.

## ■ Re-setting

In case, if the brew cycle fails to operate switch the appliance off and unplug from the power supply. Remove the rear cover and check to see if you can press the button down on the side of the boiler. If the button presses down and clicks, then **descale** the unit before next operation. If problem persists, then contact the Helpline.

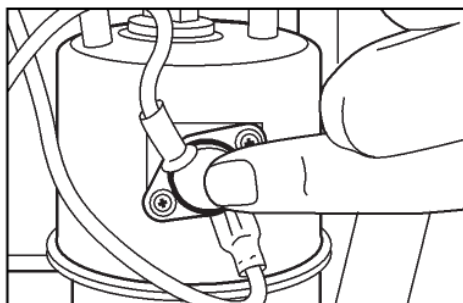

 Pour out water remained inside of machine before stock or remove.

## **Contact Information:**

If you have any questions; please contact us at the address below or show at the data plate of machine: